

RESET STORAGE

Product Specification Sheet

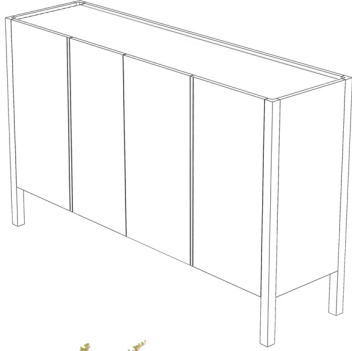

DESCRIPTION

The Reset Storage family is a sleek, sustainable multi functional storage solution for modern interiors. Featuring smart handle details hidden in the vertical lines of the solid oak doors. Inspired by architectural lines, Reset combined a document cabinet and a media dresser. The Dresser is an ode to pure craftsmanship. Choose between different heights , widths and finishes to create the perfect storage. Restore has adjustable shelves and a clean, timeless uncluttered aesthetic.

Including sustainable 130 degree hinges.
This highly practical storage solution can also act as an effective space divider within an open plan environment.

All our wooden Sideboard & Cabinets are made to measure and can be manufactured in custom sizes.

SPECIFICATIONS

Frame and doors
Solid Wood

Panels and shelves
Noble veneer

Hinges
130 degree, contract quality

MATERIALS

Solid certified European Oak, Noble Veneer
Oiled or stained colours and finished in satin matt lacquer

MARKS & COMPLIANCE

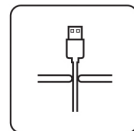
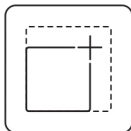

CONTENT

Details	4
Technical Specifications	5
Tailored	7
Finish options	8
Environmental Product summary	9
Product lifecycle	10
Cable Management	11



130° hinges

Technical specifications

80 x 60 cm

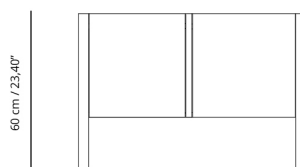
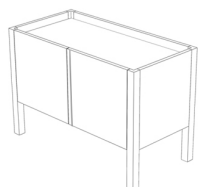

80 cm / 31,20"

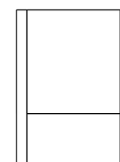

44 cm / 17,16"

80 x 100 cm

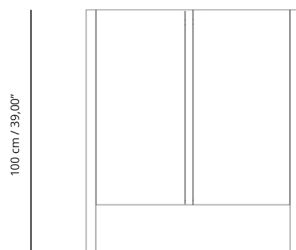
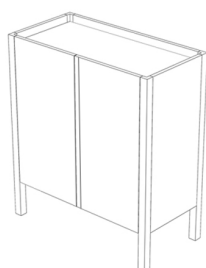

80 cm / 31,20"



44 cm / 17,16"

160 x 60 cm

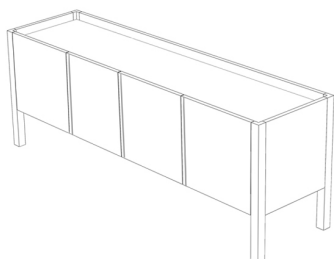

160 cm / 62,99"



44 cm / 17,16"

160 x 100 cm

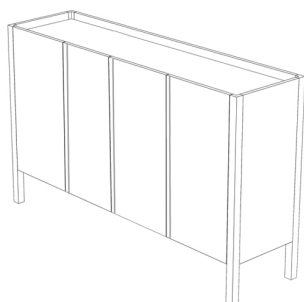

160 cm / 62,99"



Our wooden storages can be manufactured in custom sizes.

Technical specifications

80 x 150 cm

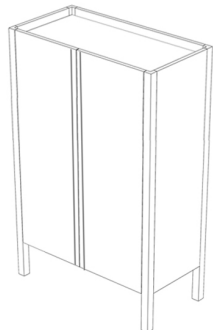

150 cm / 59,06"

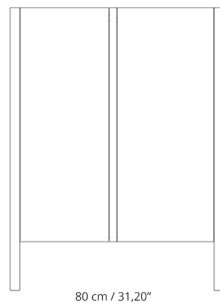

80 cm / 31,20"



44 cm / 17,16"

160 x 150 cm

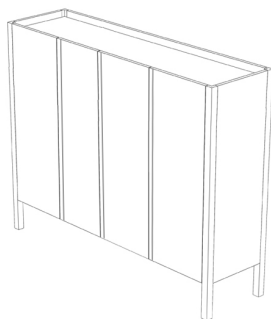

150 cm / 59,06"

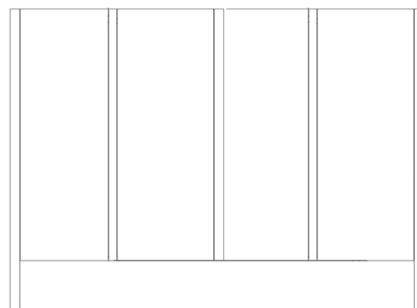

160 cm / 31,20"



44 cm / 17,16"

Our wooden Sideboards can be manufactured in custom sizes.

Tailored

Custom | Your personal design

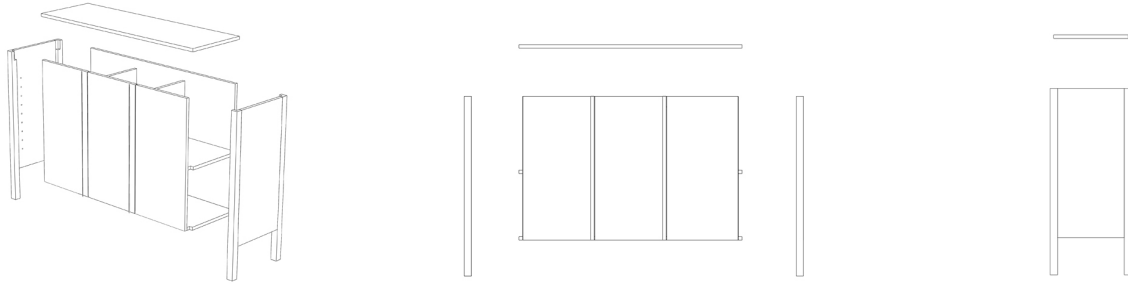

Our wooden Sideboards can be manufactured in custom sizes.

Finish options Stain

Finish Options

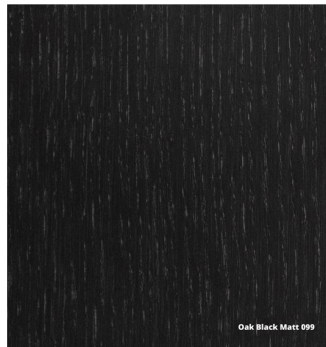

Optional - finish option inlay top/ contrast



Ral lacquered options possible, please send us your request.

Cable routing & electrification

Optional
Qi Wireless charging

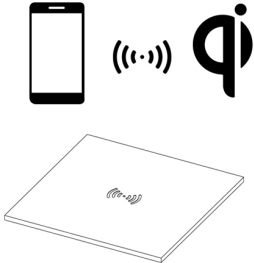

COMPATIBLE WITH Qi WIRELESS (FAST) CHARGING

Embedding invisible smart technologies
Beautifully crafted and functional Spell designs is most certainly moving along with the innovations of our time. With easy access to wireless power, we keep ourselves connected and our batteries charged.

Optional
Cable management

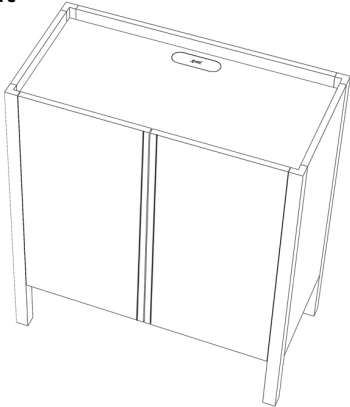

COMPATIBLE WITH CABLE MANAGEMENT

Cable routing for printers, tv and lightning.

CUSTOMER SERVICE

We are here to help.
If you have any questions,
please don't hesitate to contact us.

E-MAIL

info@spell-online.com

PHONE

+31 (0) 344 842765

