

## **BOLD SERIES**

### Product Specification Sheet

---

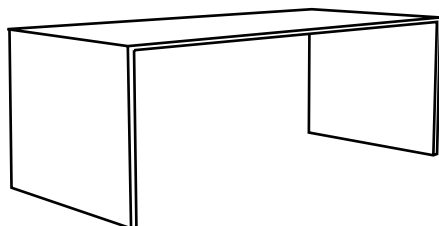

---

This document contains technical  
information about the Bold Series

---



## Material passport - Sway Series

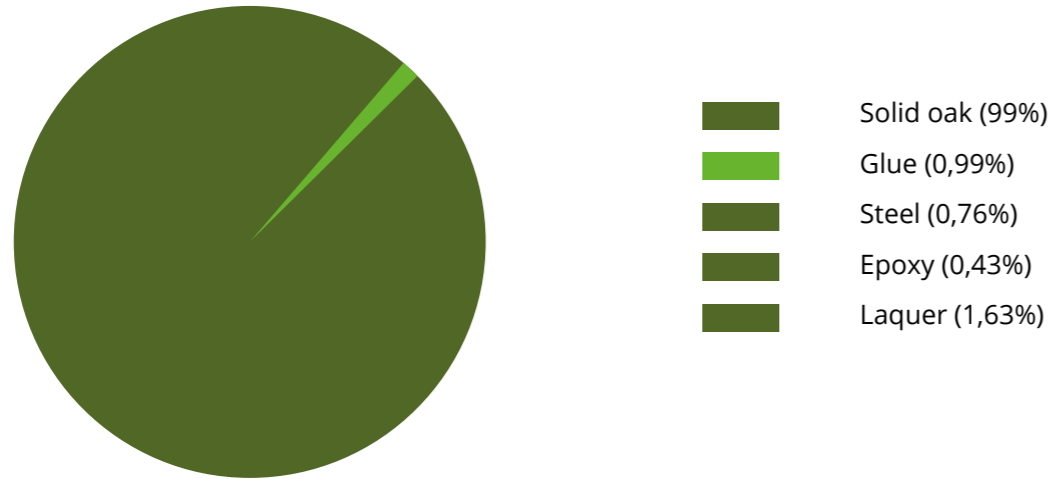

**Materials** | based on example Sway table ø: 180cm x height 75 cm

### Certificates



Official certificates documents available upon request.

### Packaging & Logistics

The packaging is tailor-made for each product, using a minimum amount of packaging material. Moreover, in this way the product is optimally packaged and well protected during transport.

In addition, we try to protect our products as much as possible during transport with packing blankets. These packing blankets are made from textile remnants, for example from residual material from local upholstery shops.

After we have delivered the products, we take the blankets back and they are reused daily. The carriers that work with Spell, just like Spell, attach great importance to sustainability. They strive to reduce CO2 emissions by, among other things, using cleaner engines, efforts to reduce fuel consumption, optimizing the loading space and optimal planning.

### Sustainability marks

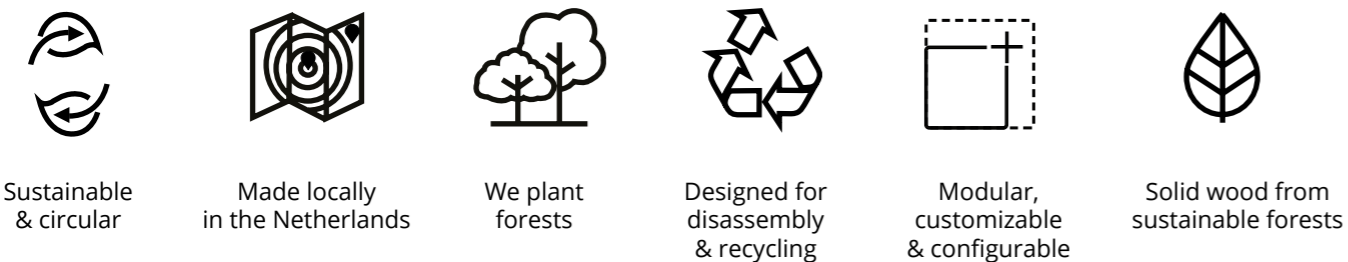

## Description

The Bold Table is an easy solution for everyday use project tables. Crafted in The Netherlands from European solid oak. Whether the backdrop for eating, or coworking, it's sure to become a dynamic and indispensable player in your space. This table has a matching Bold bench or fits on its own in your personalised layout, giving a solid and dynamic base that serves for all daily activities.

All our solid wooden tables & benches are made to measure and can be manufactured in (all) custom sizes.

## Specifications

Tabletop	Premium Solid Wood
Base	Premium Solid Wood
Accessible electrification	Various options
Including felt gliders	
Pre assembled:	No

## Materials

Solid premium Oak, Walnut or ash wood
Oiled or stained colours and finished in satin matt lacquer

View the full color overview on our website or download the material information sheet.

## Customizable

The complete Sway Series offers a broad range of furnishing options for both private and public spaces. The Sway models can be equipped with electrification applications, such as wireless charging or powersupply.



## Configurations

### Bold Table

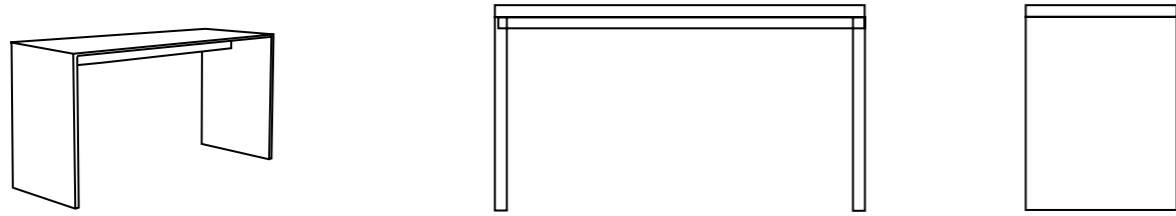

### Bold Cowork



### Bold Table Endless

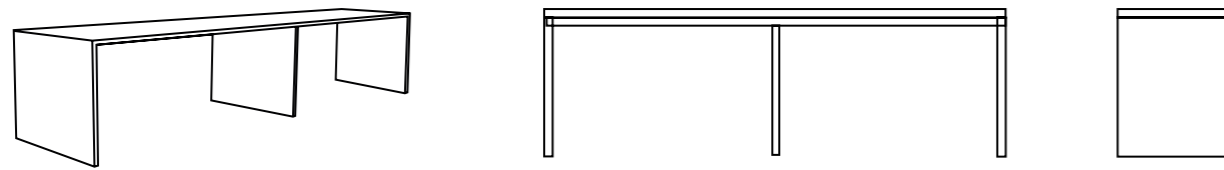

### Bold Table with privacy screen

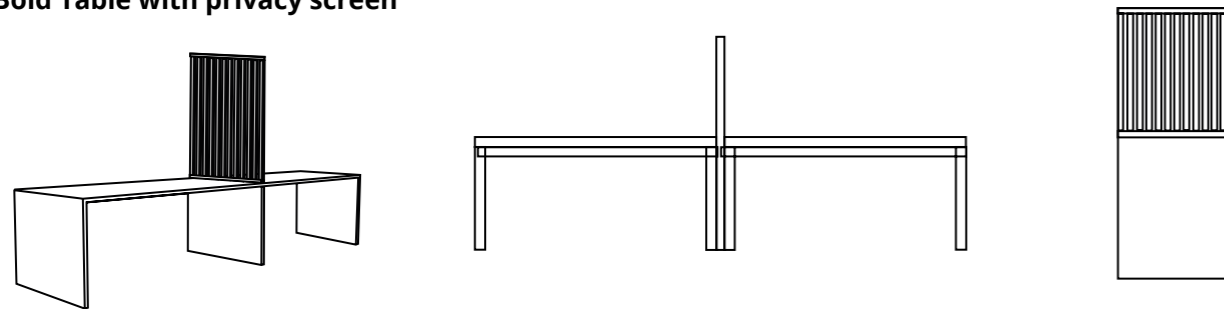

All our solid wood tables and benches are made to measure and can be manufactured in (all) custom sizes.

## Configurations

### Bold Bar

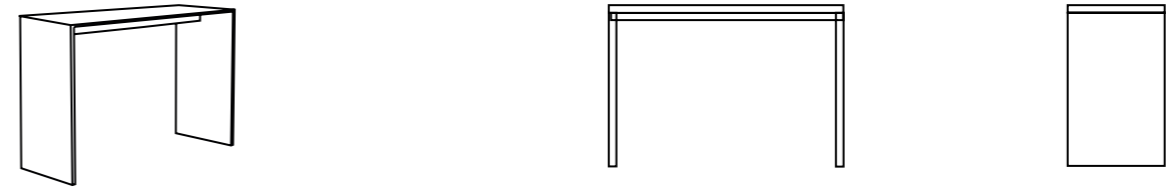

### Bold Bar

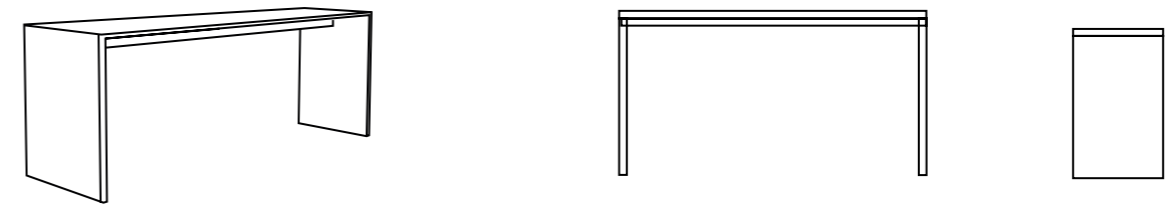

### Bold Bar Endless

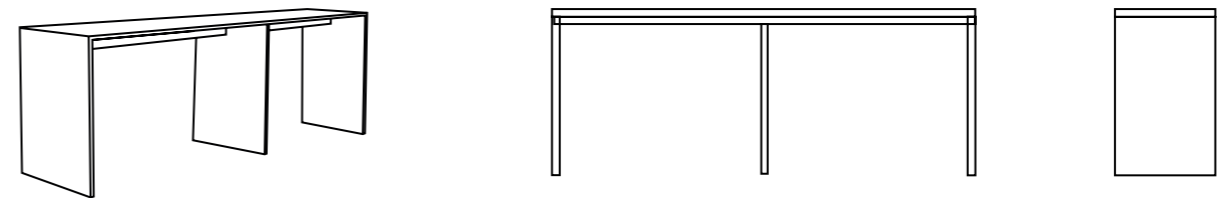

All our solid wood tables and benches are made to measure and can be manufactured in (all) custom sizes.

## Configurations

### Bold Bench



All our solid wood tables and benches are made to measure and can be manufactured in (all) custom sizes.

## Example dimensions

### Bold BENCH

Length: 120cm x Width: 40cm x Height: 46cm  
Length: 140cm x Width: 40cm x Height: 46cm  
Length: 160cm x Width: 40cm x Height: 46cm  
Length: 180cm x Width: 40cm x Height: 46cm  
Length: 200cm x Width: 40cm x Height: 46cm  
Length: 210cm x Width: 40cm x Height: 46cm  
Length: 240cm x Width: 40cm x Height: 46cm

(seating top consists of 1 part)  
(seating top consists of 1 part)  
(seating top consists of 1 part)  
(seating top consists of 1 part)  
(seating top consists of 1 part)  
(seating top consists of 1 part)  
(seating top consists of 1 part)

### Bold TABLE

Length: 200cm x Width: 80cm x Height: 76cm  
Length: 240cm x Width: 80cm x Height: 46cm  
Length: 280cm x Width: 80cm x Height: 76cm  
Length: 300cm x Width: 80cm x Height: 76cm  
Length: 320cm x Width: 80cm x Height: 76cm

(table top consists of 1 part)  
(table top consists of 1 part)  
(table top consists of 1 part)  
(table top consists of 1 part)  
(table top consists of 1 part)

Length: 200cm x Width: 100cm x Height: 76cm  
Length: 240cm x Width: 100cm x Height: 76cm  
Length: 280cm x Width: 100cm x Height: 76cm  
Length: 300cm x Width: 100cm x Height: 76cm  
Length: 320cm x Width: 100cm x Height: 76cm

(table top consists of 1 part)  
(table top consists of 1 part)  
(table top consists of 1 part)  
(table top consists of 1 part)  
(table top consists of 1 part)

Length: 200cm x Width: 120cm x Height: 76cm  
Length: 240cm x Width: 120cm x Height: 76cm  
Length: 280cm x Width: 120cm x Height: 76cm  
Length: 300cm x Width: 120cm x Height: 76cm  
Length: 320cm x Width: 120cm x Height: 76cm

(table top consists of 1 part)  
(table top consists of 1 part)  
(table top consists of 1 part)  
(table top consists of 1 part)  
(table top consists of 1 part)

### Bold BAR

Length: 200cm x Width: 100cm x Height: 90-110cm  
Length: 240cm x Width: 100cm x Height: 90-110cm  
Length: 280cm x Width: 100cm x Height: 90-110cm  
Length: 300cm x Width: 100cm x Height: 90-110cm  
Length: 320cm x Width: 100cm x Height: 90-110cm

(seating top consists of 1 part)  
(seating top consists of 1 part)  
(seating top consists of 1 part)  
(seating top consists of 1 part)  
(seating top consists of 1 part)

### Bold ENDLESS

Length: 400cm x Width: 120cm x Height: 76cm  
Length: 440cm x Width: 120cm x Height: 76cm  
Length: 480cm x Width: 120cm x Height: 76cm  
Length: 520cm x Width: 120cm x Height: 76cm  
Length: 600cm x Width: 120cm x Height: 76cm

(table top consists of 2 parts)  
(table top consists of 2 parts)  
(table top consists of 2 parts)  
(table top consists of 2 parts)  
(table top consists of 2 or 3 parts)

All our solid wood tables and benches are made to measure and can be manufactured in (all) custom sizes.

## Edge finish options

Chamfered

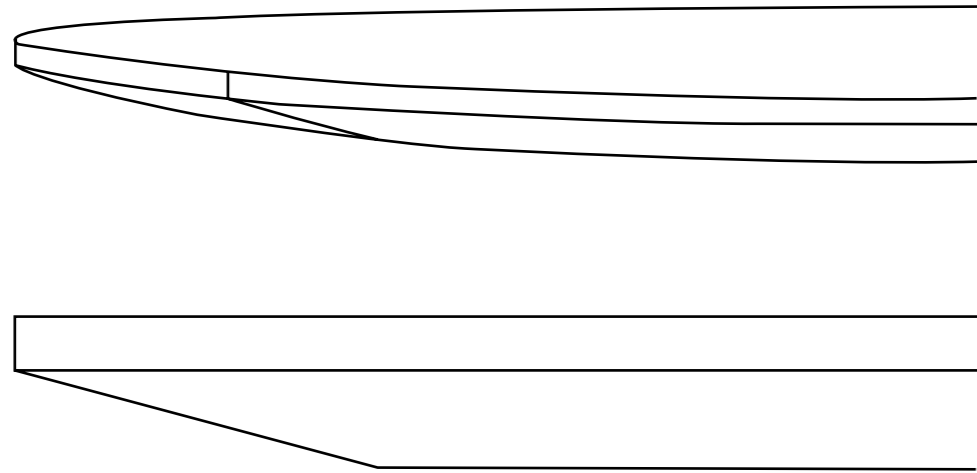

Straight

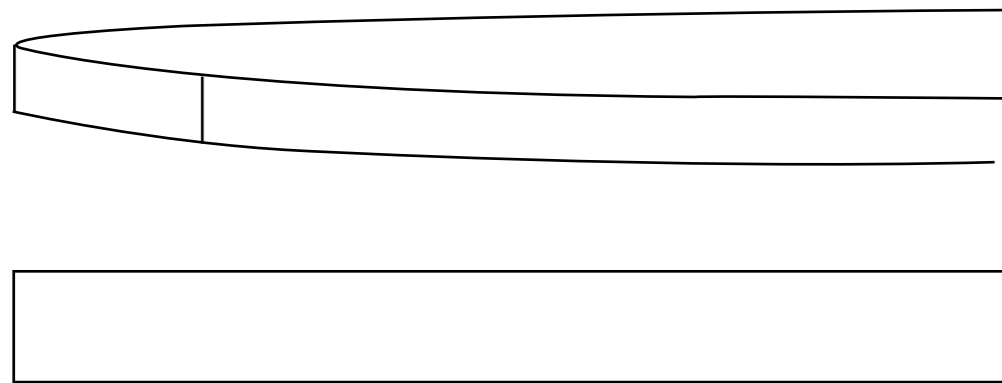

## Cable management & electrification options

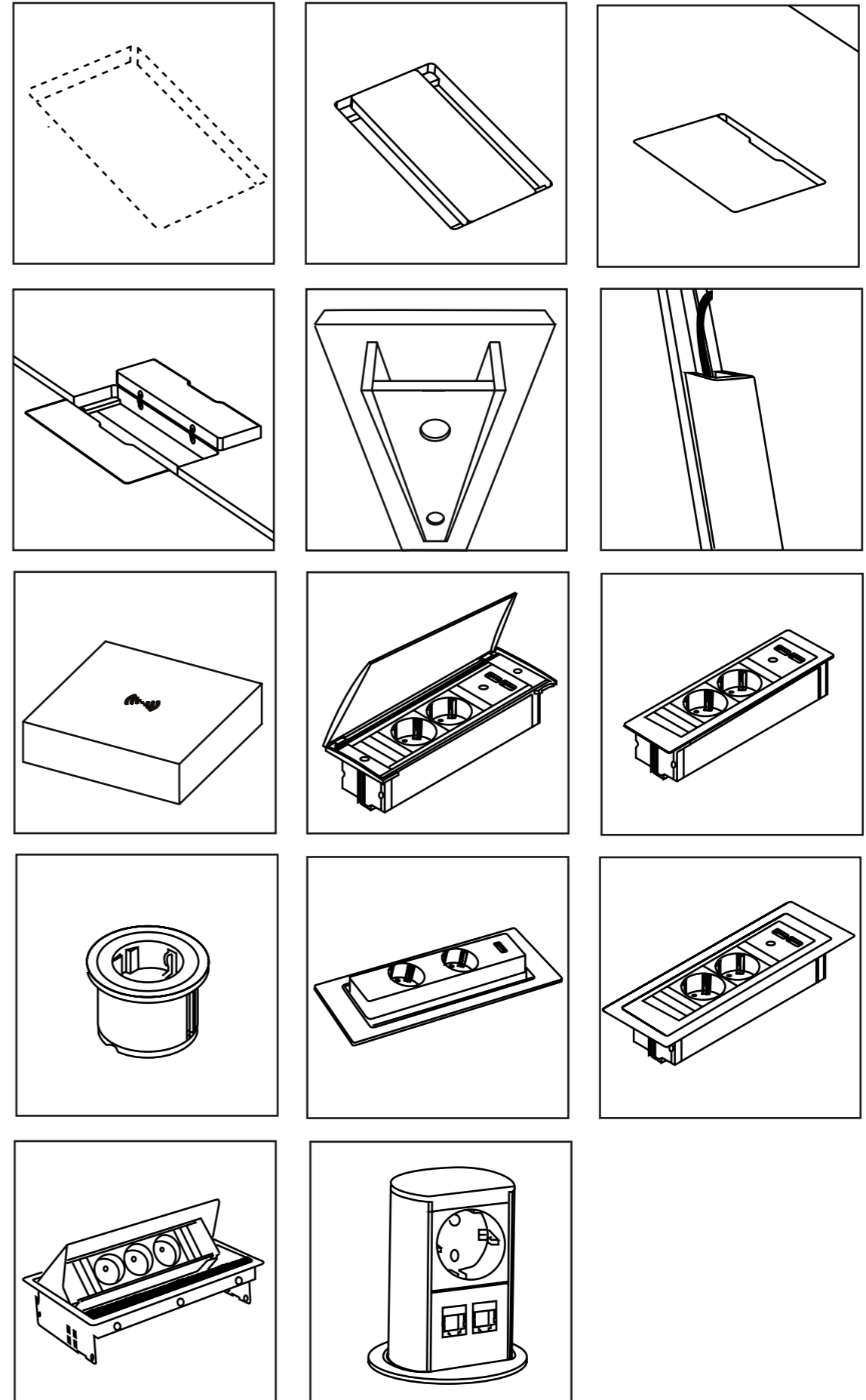

Case studies



Case studies

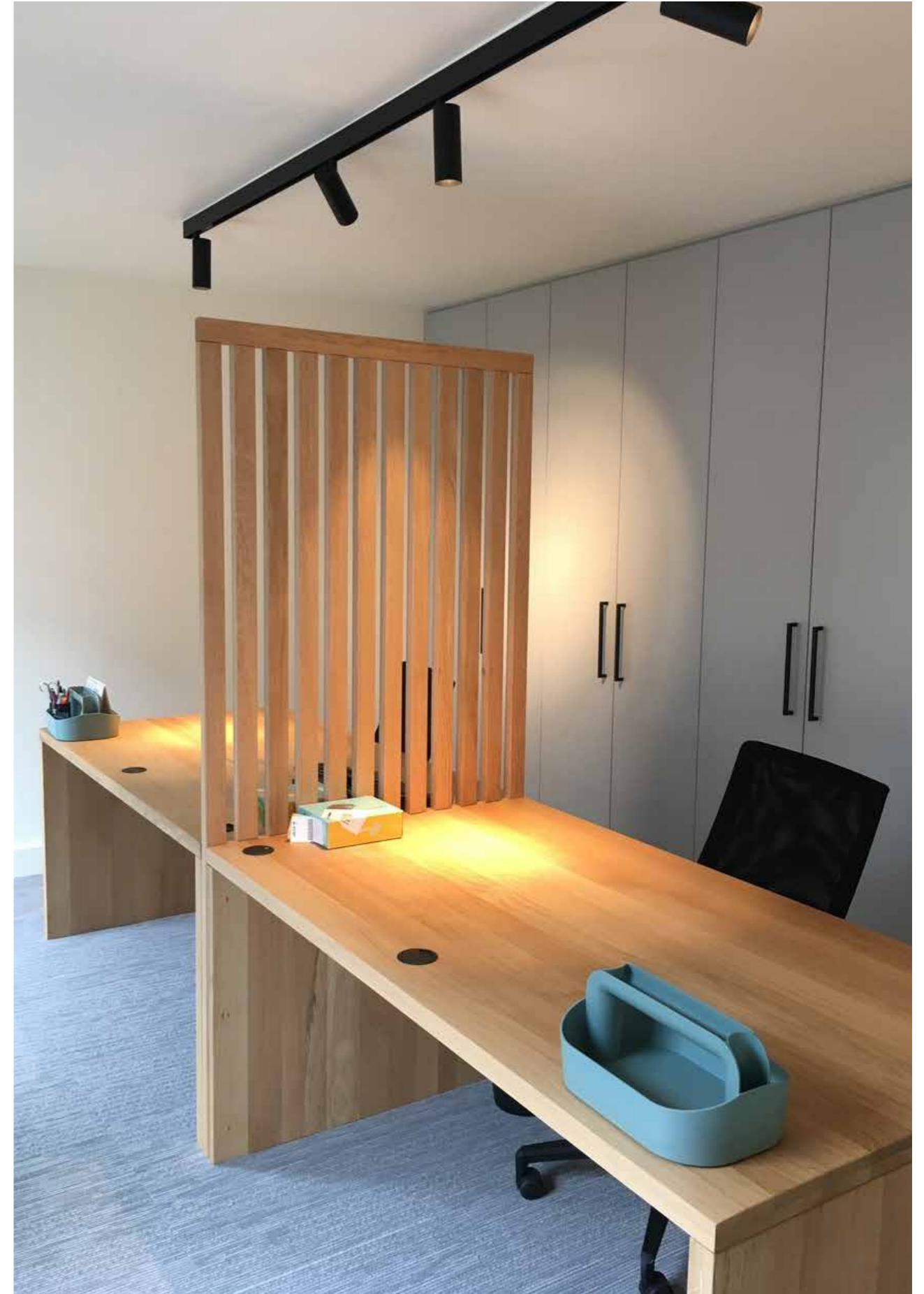

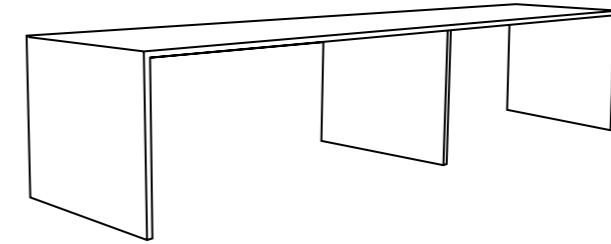

**SUPPORT**

We are here to help.  
If you have any questions,  
please don't hesitate to contact us.

**E-MAIL**

[info@spell-furniture.com](mailto:info@spell-furniture.com)

**PHONE**

+31 (0) 344 842765