

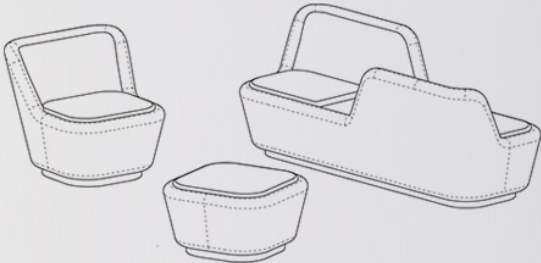

SHUFFLE MODULAR LINE

Product Technical Specification



DISCRIPTION

The Shuffle Modular Line combines smart production techniques with traditional, first-class furniture craftsmanship in a timeless and characterful design.

The collection easily accommodates the demands of modern interiors for flexibility and it has been designed with respect for the raw materials. Smart frame technology – Where standard sofas are generally right-angled, square and predictable, the Shuffle offers the architectural freedom to challenge or tackle any type of room. The Shuffle Line uses smart frame technology offering the possibility to efficiently achieve almost any conceivable organic model.

With the freedom to create a visually expressive environment, Shuffle meets a range of requirements for private and public spaces with its various seating modules, hockers and table options. Available in numerous textiles, the Smart Frame Technology allows the modules to be combined flexibly to create unique seating landscapes.

With its rich upholstery and beautiful wood elements, the Shuffle is perfect for creating a homely atmosphere.

SPECIFICATIONS

Body
Plywood, Foam and Fabric

Base
Walnut veneer, Oak veneer or HPL

Tech
Qi Integration, Powersupply



MATERIALS

Eco plywood
High Resilience Foam
Fabric
Walnut, Oak, HPL
Adjustable feets, Felt gliders
Smart Integration (Optional)

YOUR DESIGN, OUR PERSONALISED OPTIONS

Designed by our in-house design team, the Shuffle Modular Line is fully customisable. This collection allows you to mix and match endlessly, or as we say: to shuffle. Select the desired model, choose the textile, and select the base element.

Complement your design with integrated tables and even the latest technologies.



CONTENT

Configurations	4
Dimensions	6
Tech features	9
Base features	10
Fabric groups	11
Social	25

SHUFFLE WALNUT



Configurations

Shuffle
Easy Chair



Shuffle
Hocker

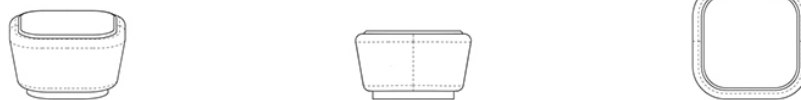

Shuffle
Table

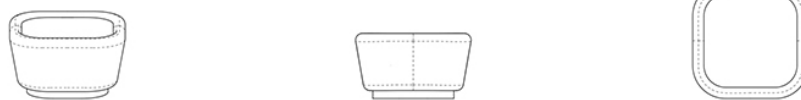

Shuffle
Two Seat Bench



Shuffle
Three Seat Bench



Shuffle
Three Seat Bench
With Table



Configurations

Shuffle
Two Seat Sofa

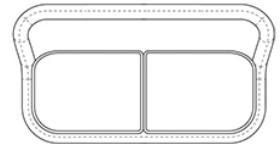
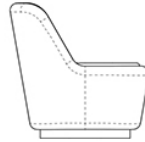
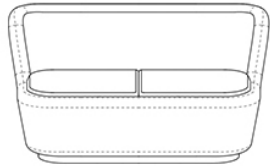

Shuffle
Three Seat Sofa

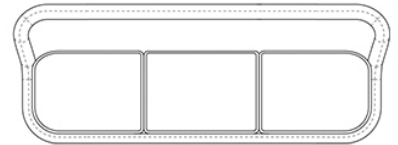
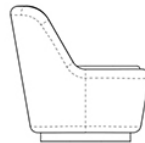
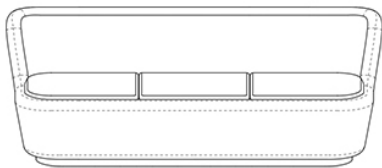

Shuffle
Two Seat Sofa
With Table

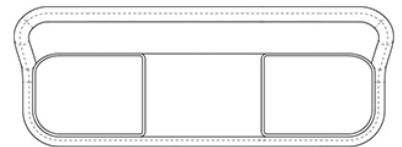
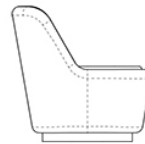
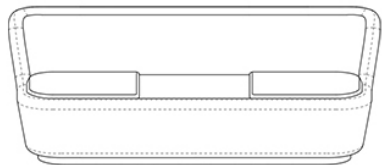

Shuffle
Wing

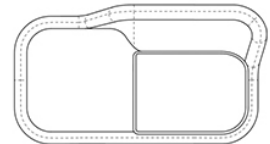
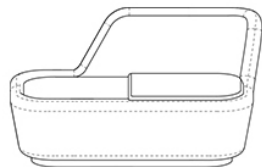

Shuffle
Pair Wing

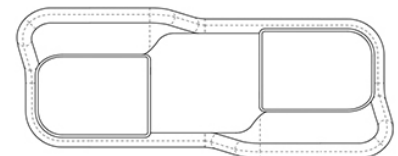
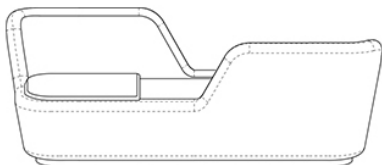

Dimensions

Hocker/ Table

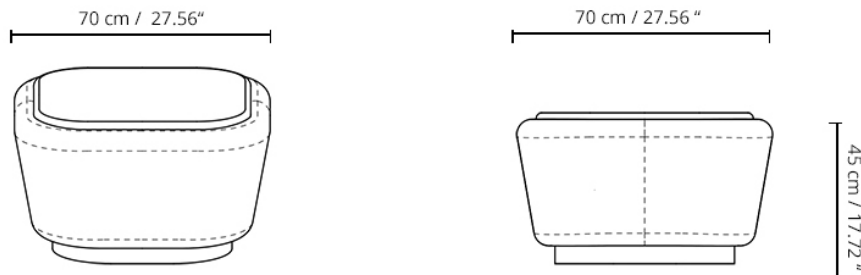

Easy Chair

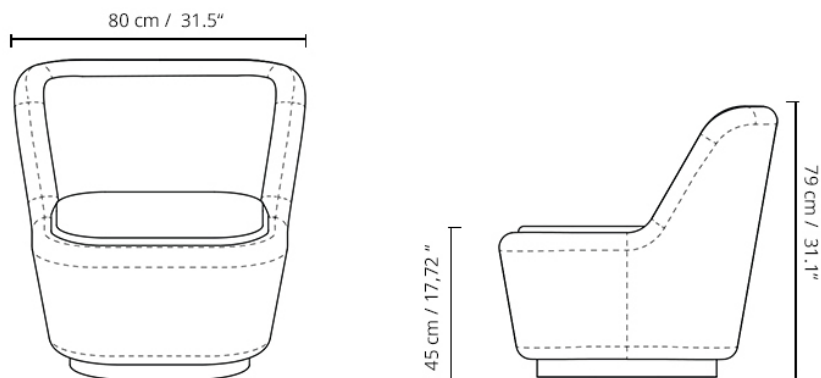

Two Seat Bench

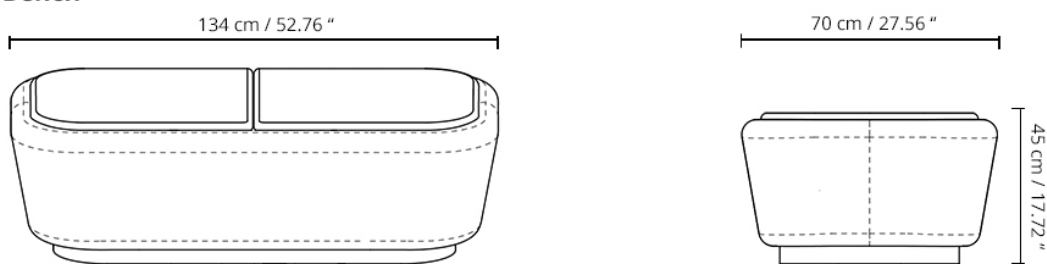

Three Seat Bench

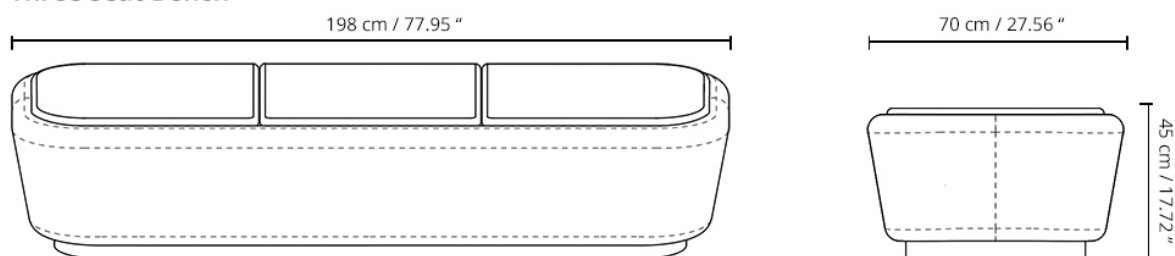

Dimensions

Two Seat sofa

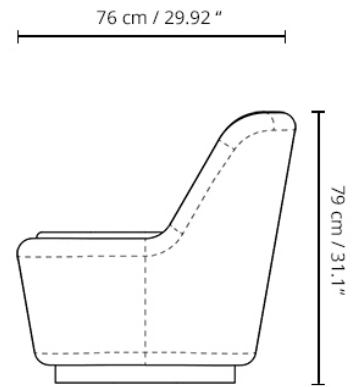
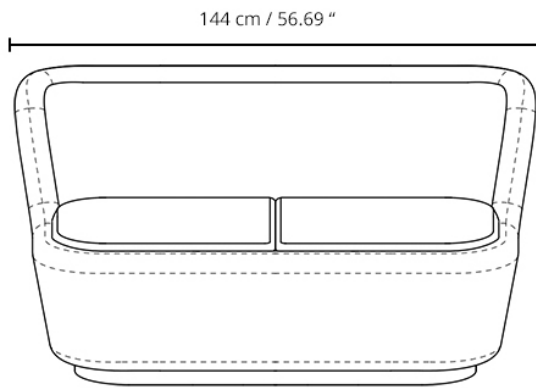

Three Seat sofa

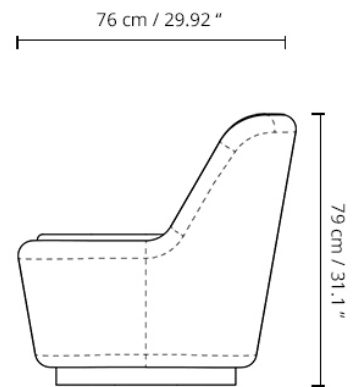
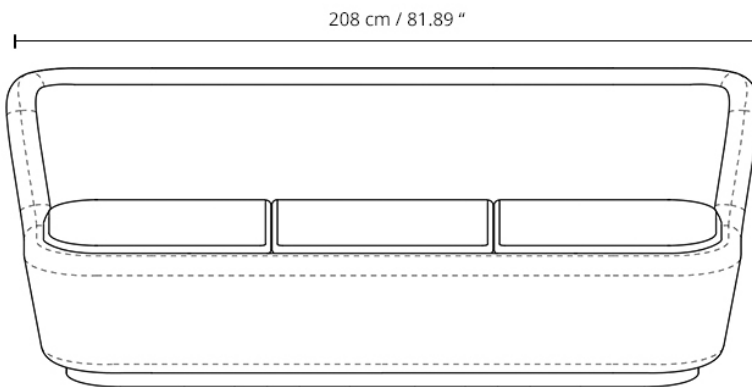

Dimensions

Wing

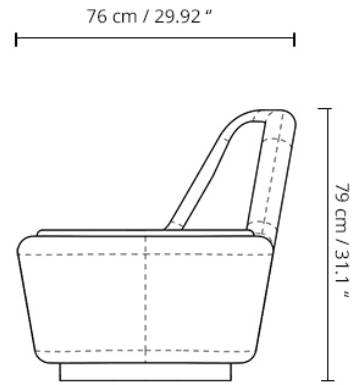
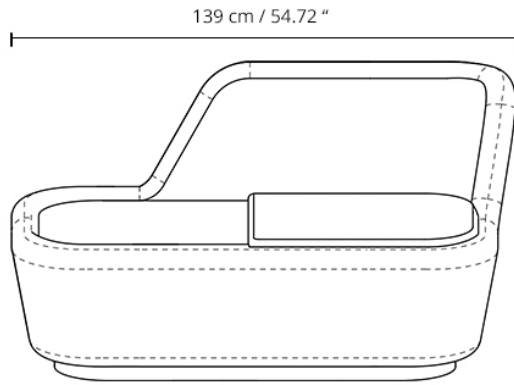

Pair Wing

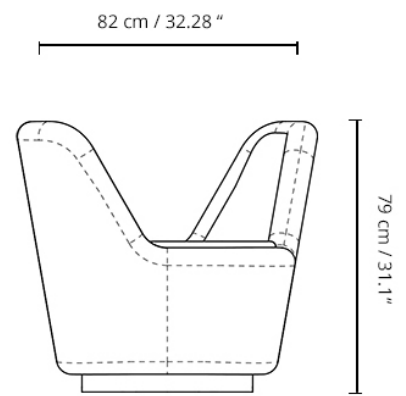
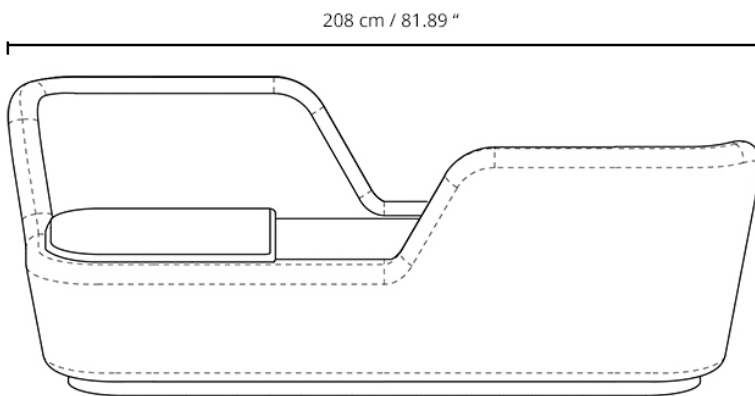

Technical Integration Features

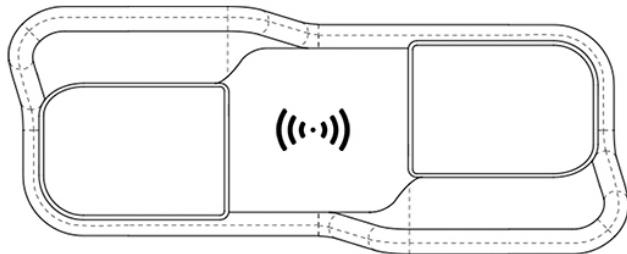

*Integrated in the tabletop.
(Not possible in combination with
the Shuffle pouf)

COMPATIBLE WITH Qi WIRELESS CHARGING

As mobile work moves around, it often needs to spread out at universities, in hotel rooms, even in creative business environments. This unique work lounge creates a comforting personal space for phone calls.



Fast Wireless Charging

Embedding invisible smart technologies Beautifully crafted and functional Spell designs is most certainly moving along with the innovations of our time. With easy access to wireless power, we keep ourselves connected and our batteries charged.

COMPATIBLE WITH SPLITSCREEN LAPTOP TABLE

The matching Splitscreen Laptop table provides the ideal angle to work on your laptop or tablet and to get things done.

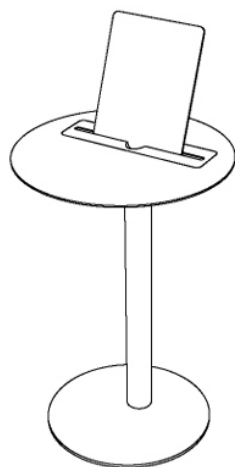
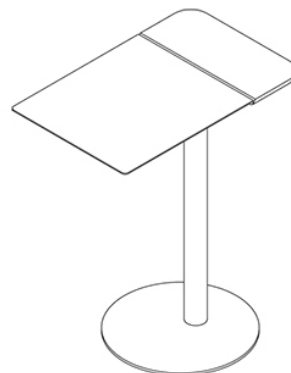

COMPATIBLE WITH NOMAD TABLET TABLE

The matching Nomad Tablet Table provides the ideal angle to work on your tablet.



Base Features

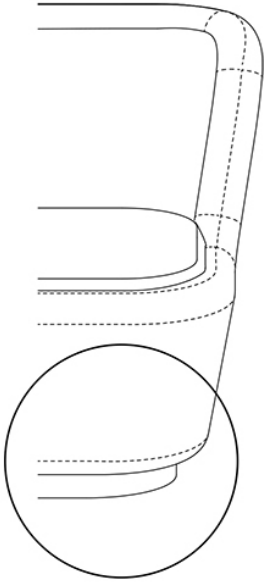

* The displayed Pair Wing Sofa base is made out of Walnut



This collection allows you to mix and match endlessly, or as we say: to shuffle.
Select the desired model, choose the textile, and select the base element.

If you select the model with a tabletop; the wood will be the same in both configurations

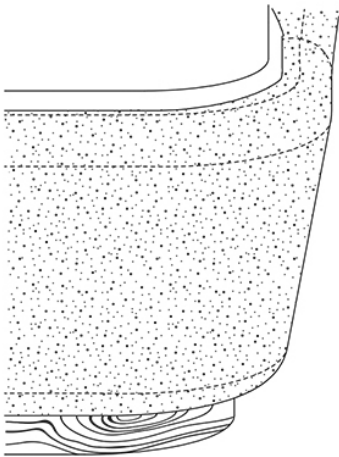

Walnut veneer laminates

Select the wood base accent of your choice.

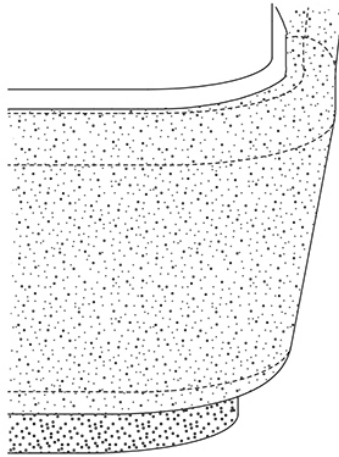

Oak veneer laminates

Select the wood base accent of your choice.

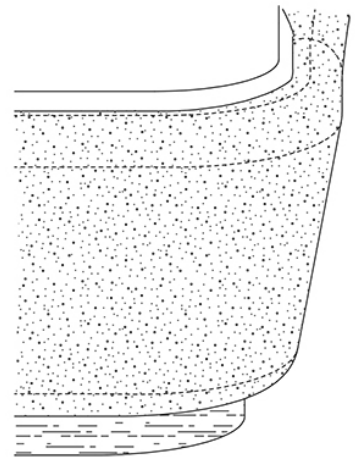

HPL laminates

Select the HPLbase accent of your choice.

Fabric groups



FABRICS [Group 1]

Kvadrat Remix 2

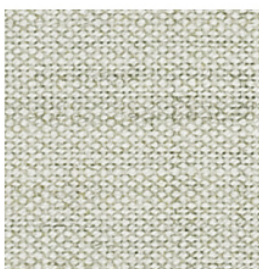

Remix 0113

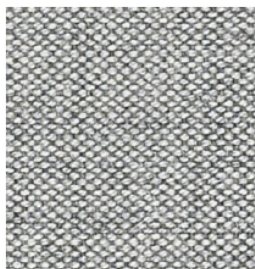

Remix 0123

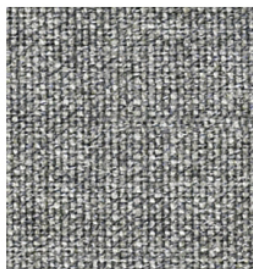

Remix 0133

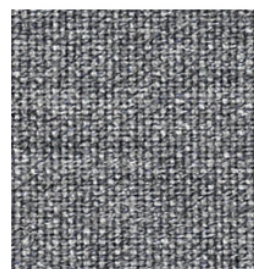

Remix 0143



Remix 0152

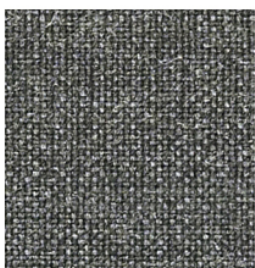

Remix 0163



Remix 0173

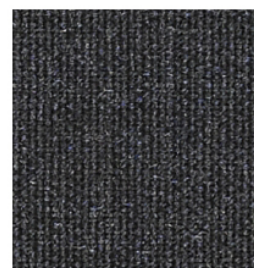

Remix 0183



Remix 0223

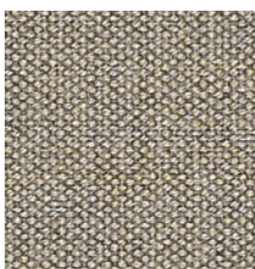

Remix 0233



Remix 0242



Remix 0252



Remix 0362



Remix 0373

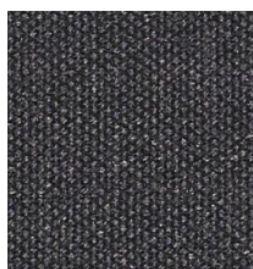

Remix 0383

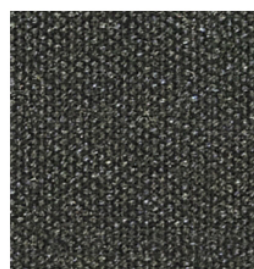

Remix 0393

Name: Kvadrat Remix 2

Material: 90% New wool (worsted), 10% Nylon

Weight / abrasion: 415 g/lin.m

lightfastness: 6-7

samples and colours: www.kvadrat.dk

FABRICS [Group 1]

Kvadrat Remix 2



Remix 412

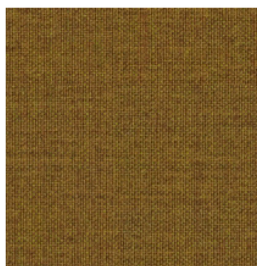

Remix 0422



Remix 0433



Remix 0443



Remix 0452



Remix 0543

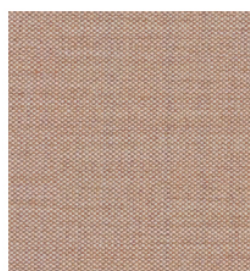

Remix 0612

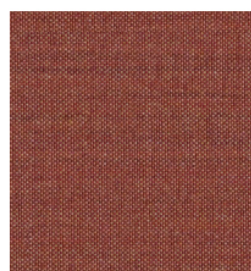

Remix 0632

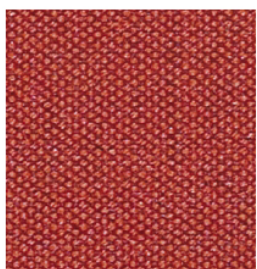

Remix 0643



Remix 0653

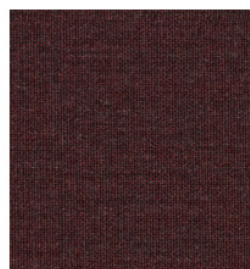

Remix 0662

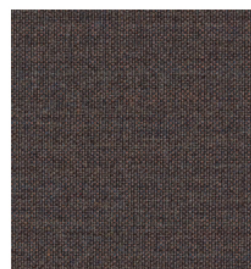

Remix 0672

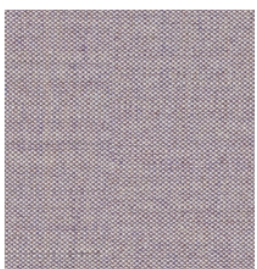

Remix 0682



Remix 0692

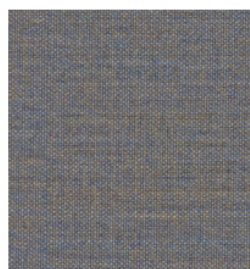

Remix 0722

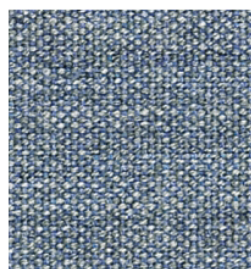

Remix 0733

Name: Kvadrat Remix 2

Material: 90% New wool (worsted), 10% Nylon

Weight / abrasion: 415 g/lin.m

lightfastness: 6-7

samples and colours: www.kvadrat.dk

FABRICS [Group 1]

Kvadrat Remix 2

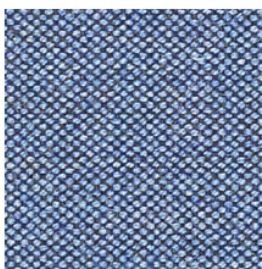

Remix 0743

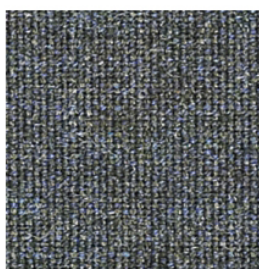

Remix 0753

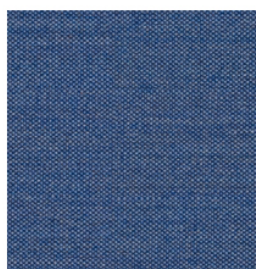

Remix 0762

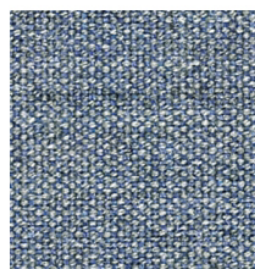

Remix 0773



Remix 0783

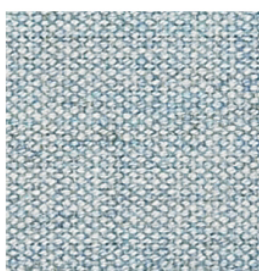

Remix 0823

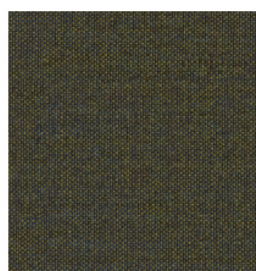

Remix 0842

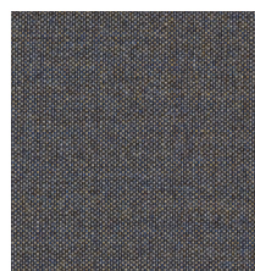

Remix 0852

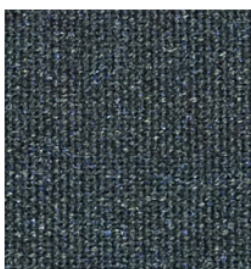

Remix 0873



Remix 0912

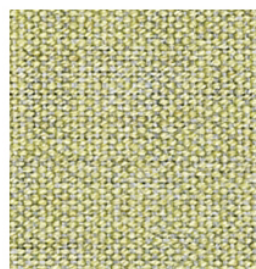

Remix 0923

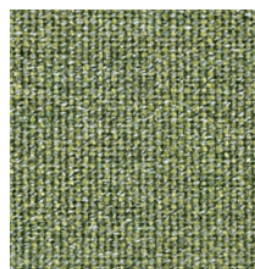

Remix 0933



Remix 0942

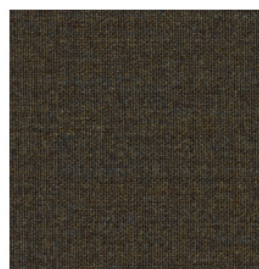

Remix 0954



Remix 0962



Remix 0973

Name: Kvadrat Remix 2

Material: 90% New wool (worsted), 10% Nylon

Weight / abrasion: 415 g/lin.m

lightfastness: 6-7

samples and colours: www.kvadrat.dk

FABRICS [Group 2]

Kvadrat Melange NAP

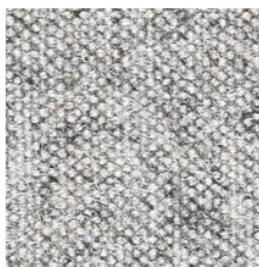

Melange NAP 0111



Melange NAP 0171

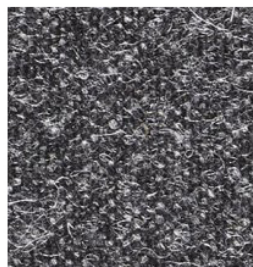

Melange NAP 0191



Melange NAP 0211



Melange NAP 0221



Melange NAP 0241



Melange NAP 0271



Melange NAP 0321



Melange NAP 0351



Melange NAP 0371



Melange NAP 0411



Melange NAP 0461

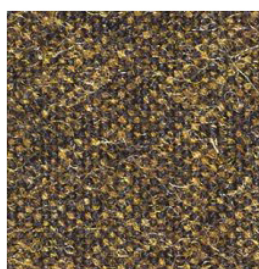

Melange NAP 0491



Melange NAP 0521



Melange NAP 0551

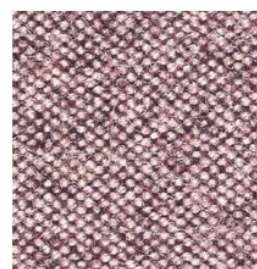

Melange NAP 0651

Name: Kvadrat Melange NAP

Material: 97% New wool (worsted), 3% Nylon

Weight / abrasion: 440 g/lin.m

lightfastness: 6

samples and colours: www.kvadrat.dk

FABRICS [Group 2]

Kvadrat Melange NAP



Melange NAP 0691

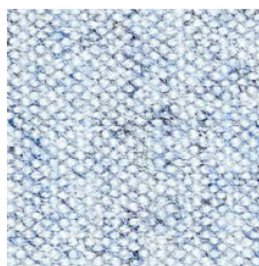

Melange NAP 0711



Melange NAP 0751

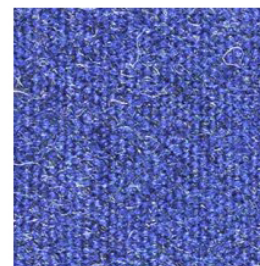

Melange NAP 0771



Melange NAP 0791



Melange NAP 0871



Melange NAP 0911

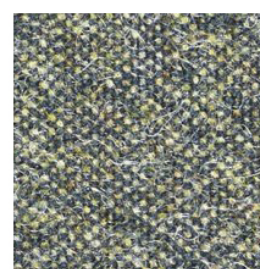

Melange NAP 0951



Melange NAP 0991

Name: Kvadrat Melange NAP

Material: 97% New wool (worsted), 3% Nylon

Weight / abrasion: 440 g/lin.m

lightfastness: 6

samples and colours: www.kvadrat.dk

FABRICS [Group 3]

Kvadrat Steelcut Trio 3

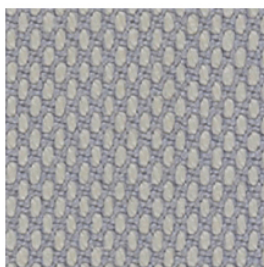

Steelcut Trio 0105

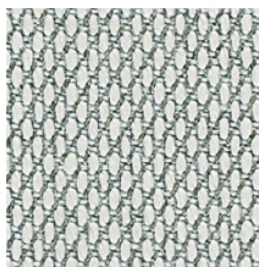

Steelcut Trio 0113

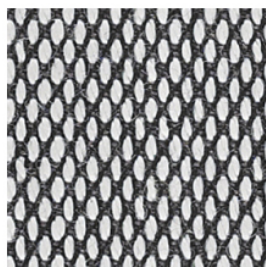

Steelcut Trio 0124

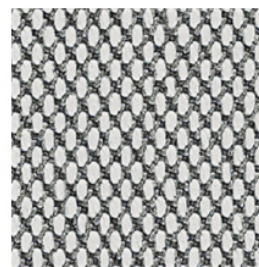

Steelcut Trio 0133

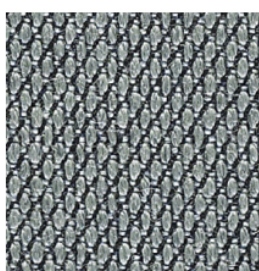

Steelcut Trio 0153

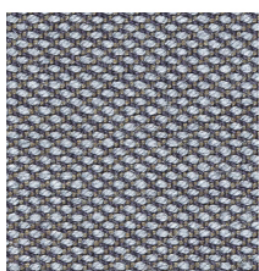

Steelcut Trio 0176

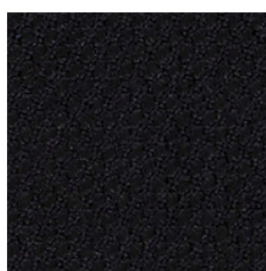

Steelcut Trio 0195

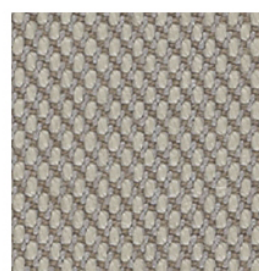

Steelcut Trio 0205

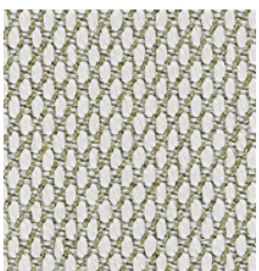

Steelcut Trio 0213

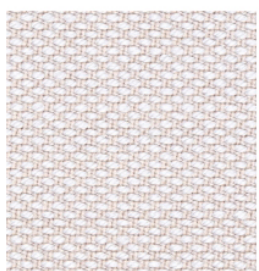

Steelcut Trio 0226

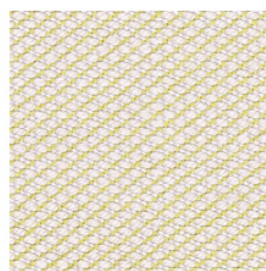

Steelcut Trio 0236

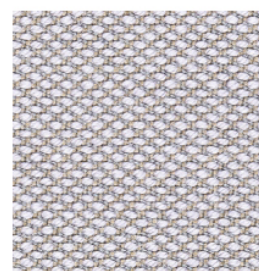

Steelcut Trio 0246

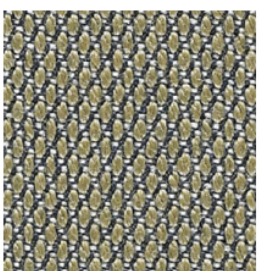

Steelcut Trio 0253

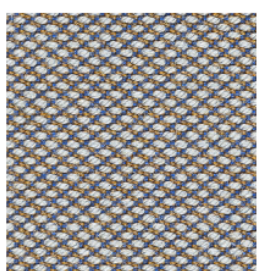

Steelcut Trio 0266

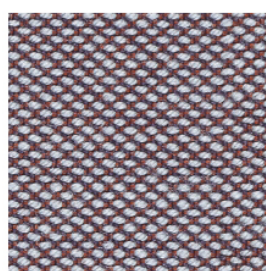

Steelcut Trio 0276

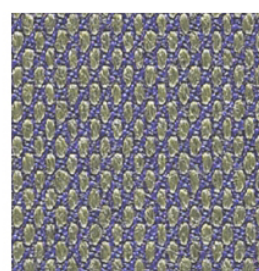

Steelcut Trio 0283

Name: Kvadrat Steelcut Trio 3

Material: 90% New wool (worsted), 10% Nylon

Weight / abrasion: 770 g/lin.m

lightfastness: 7

samples and colours: www.kvadrat.dk

FABRICS [Group 3]

Kvadrat Steelcut Trio 3

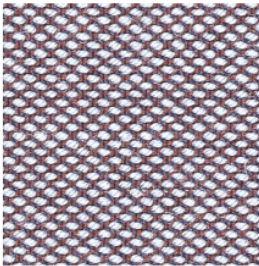

Steelcut Trio 0336



Steelcut Trio 0376

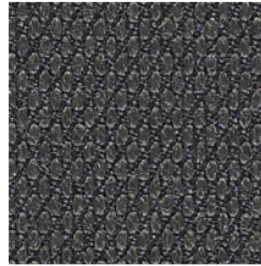

Steelcut Trio 0383

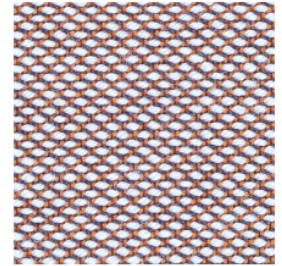

Steelcut Trio 0416

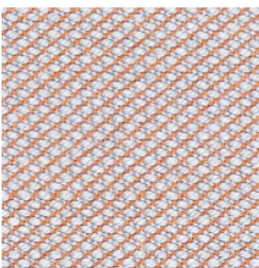

Steelcut Trio 0426

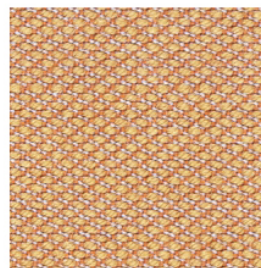

Steelcut Trio 0436

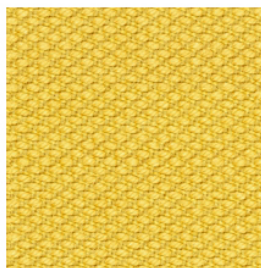

Steelcut Trio 0446

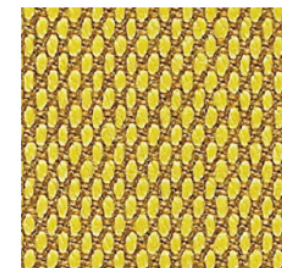

Steelcut Trio 0453

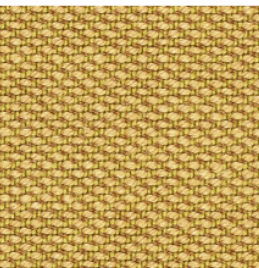

Steelcut Trio 0466

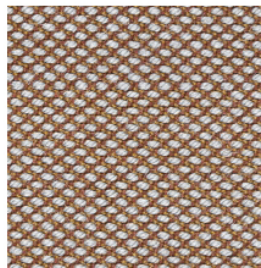

Steelcut Trio 0476

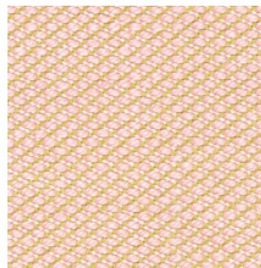

Steelcut Trio 0506

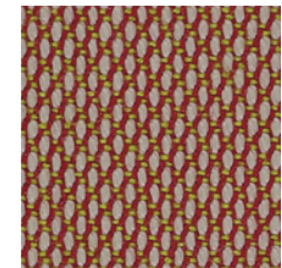

Steelcut Trio 0515

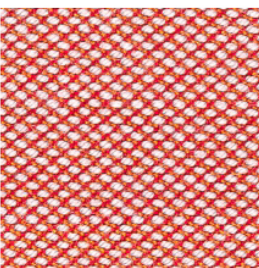

Steelcut Trio 0526



Steelcut Trio 0533

Name: Kvadrat Steelcut Trio 3

Material: 90% New wool (worsted), 10% Nylon

Weight / abrasion: 770 g/lin.m

lightfastness: 7

samples and colours: www.kvadrat.dk

FABRICS [Group 3]

Kvadrat Steelcut Trio 3

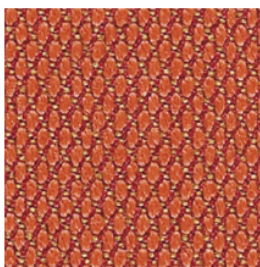

Steelcut Trio 0553

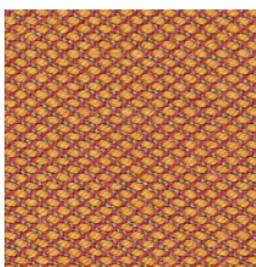

Steelcut Trio 0576

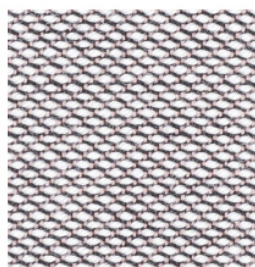

Steelcut Trio 0616

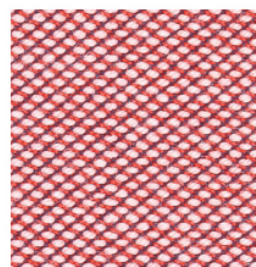

Steelcut Trio 0636



Steelcut Trio 0645

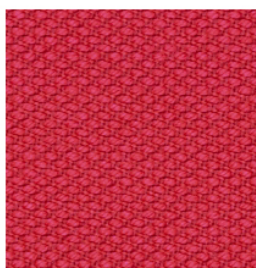

Steelcut Trio 0666

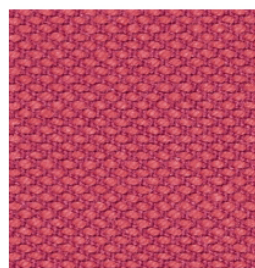

Steelcut Trio 0686

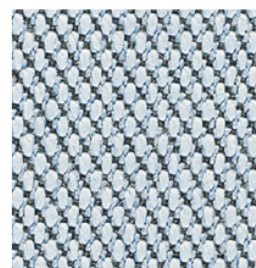

Steelcut Trio 0713

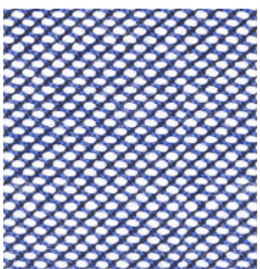

Steelcut Trio 0716

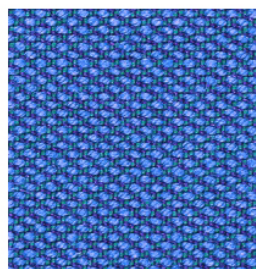

Steelcut Trio 0746

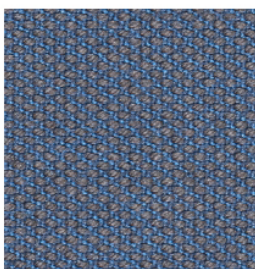

Steelcut Trio 0756

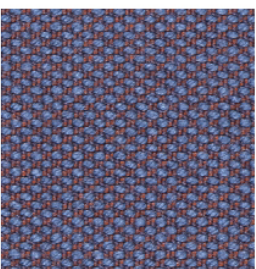

Steelcut Trio 0776

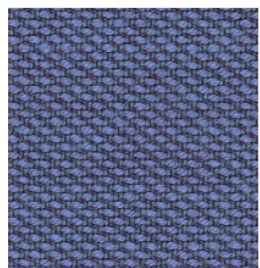

Steelcut Trio 0796

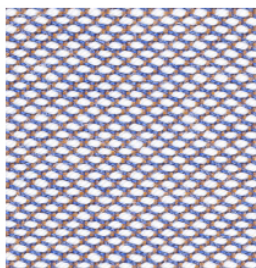

Steelcut Trio 0806



Steelcut Trio 0865

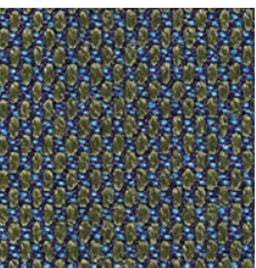

Steelcut Trio 0883

Name: Kvadrat Steelcut Trio 3

Material: 90% New wool (worsted), 10% Nylon

Weight / abrasion: 770 g/lin.m

lightfastness: 7

samples and colours: www.kvadrat.dk

FABRICS [Group 3]

Kvadrat Steelcut Trio 3



Steelcut Trio 0906

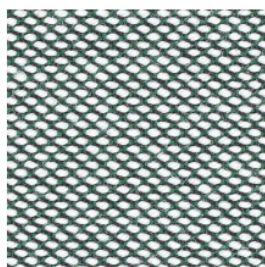

Steelcut Trio 0916

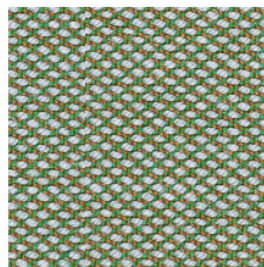

Steelcut Trio 0946

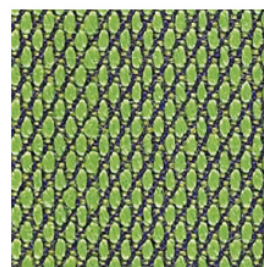

Steelcut Trio 0953

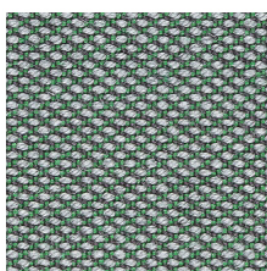

Steelcut Trio 0966

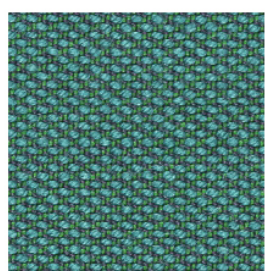

Steelcut Trio 0976

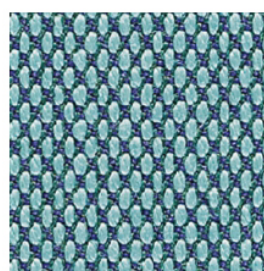

Steelcut Trio 0983

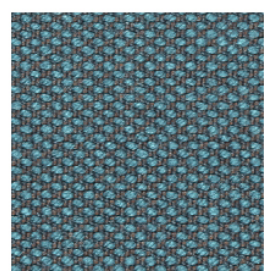

Steelcut Trio 0996

Name: Kvadrat Steelcut Trio 3

Material: 90% New wool (worsted), 10% Nylon

Weight / abrasion: 770 g/lin.m

lightfastness: 7

samples and colours: www.kvadrat.dk

FABRICS [Group 4]

Kvadrat Fiord

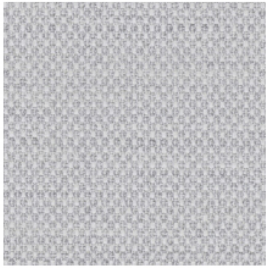

Fiord 0101

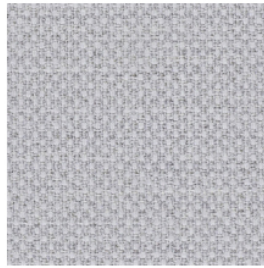

Fiord 0121

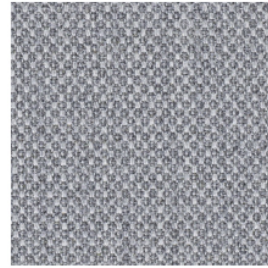

Fiord 0151

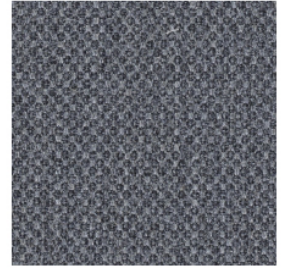

Fiord 0171



Fiord 0191



Fiord 0201

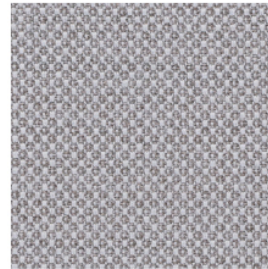

Fiord 0251



Fiord 0271

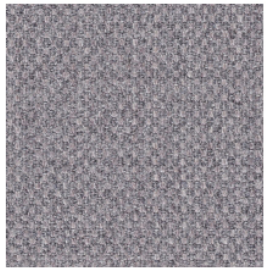

Fiord 0351



Fiord 0371



Fiord 0391

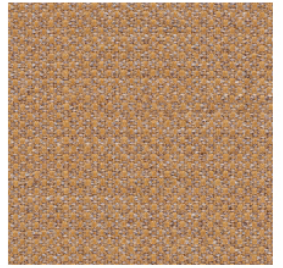

Fiord 0451

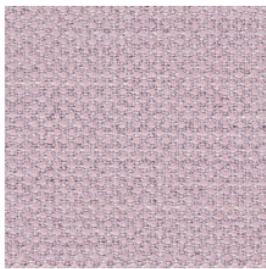

Fiord 0521

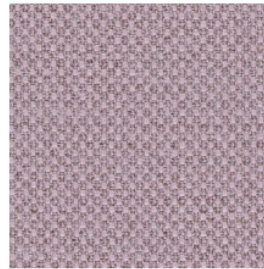

Fiord 0551

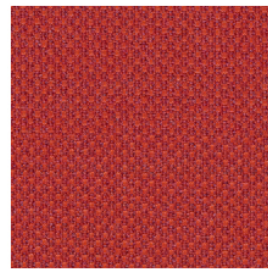

Fiord 0571

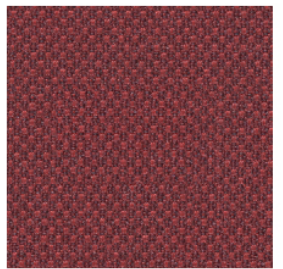

Fiord 0581

Name: Kvadrat Fiord

Material: 92% New wool (worsted), 8% Nylon

Weight / abrasion: 500 g/lin.m

lightfastness: 6

samples and colours: www.kvadrat.dk

FABRICS [Group 4]

Kvadrat Fiord



Fiord 0591

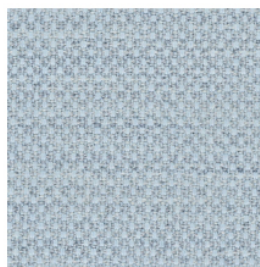

Fiord 0721

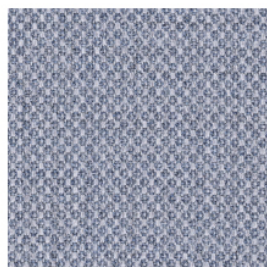

Fiord 0751

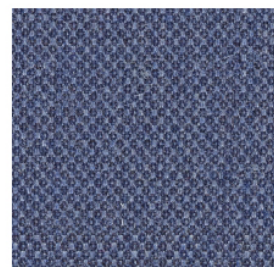

Fiord 0771

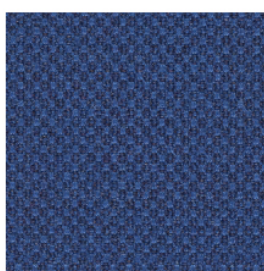

Fiord 0791

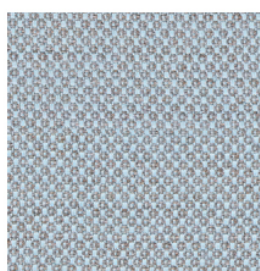

Fiord 0821

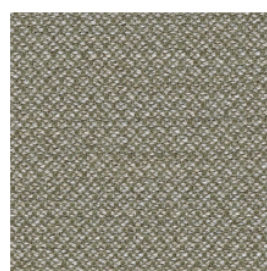

Fiord 0951



Fiord 0961

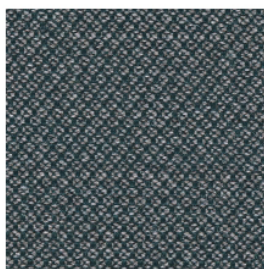

Fiord 0971



Fiord 0981

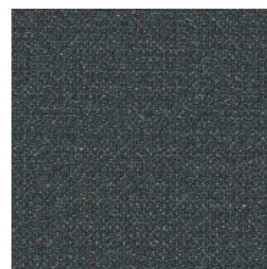

Fiord 0991

Name: Kvadrat Fiord

Material: 92% New wool (worsted), 8% Nylon

Weight / abrasion: 500 g/lin.m

lightfastness: 6

samples and colours: www.kvadrat.dk

FABRICS [Group 5]

Kvadrat Divina MD

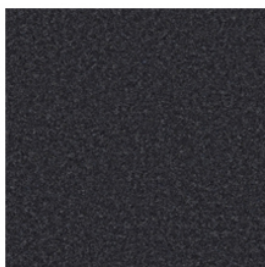

Divina 0193



Divina 0203



Divina 0213



Divina 0293



Divina 0343



Divina 0353



Divina 0363



Divina 0413



Divina 0433



Divina 0453



Divina 0613



Divina 0633

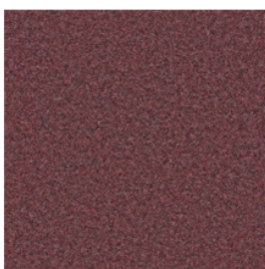

Divina 0653



Divina 0673

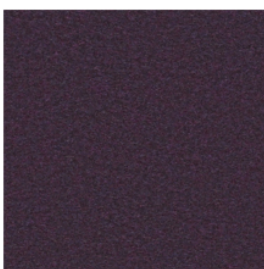

Divina 0683



Divina 0713

Name: Kvadrat Divina MD

Material: 100% New wool

Weight / abrasion: 840 g/lin.m

lightfastness: 6

samples and colours: www.kvadrat.dk

FABRICS [Group 5]

Kvadrat Divina MD

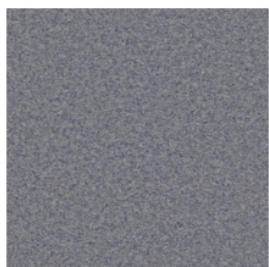

Divina 0733



Divina 0743

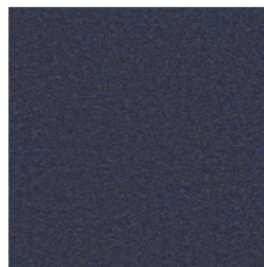

Divina 0753

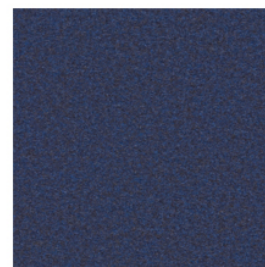

Divina 0773

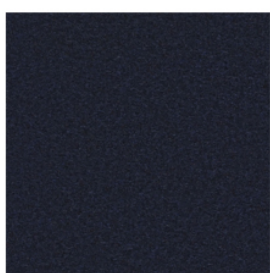

Divina 0783



Divina 0813

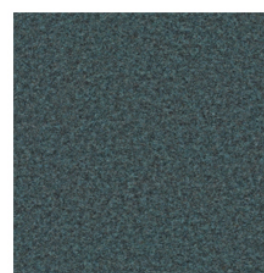

Divina 0843



Divina 0873



Divina 0913

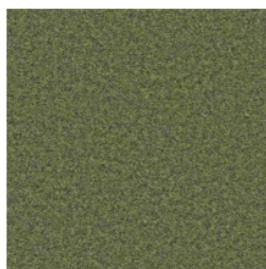

Divina 0943

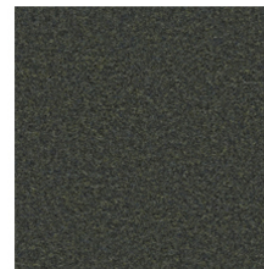

Divina 0973

Name: Kvadrat Divina MD

Material: 100% New wool

Weight / abrasion: 840 g/lin.m

lightfastness: 6

samples and colours: www.kvadrat.dk

Social



MODERN TRIBES

The best workplaces, are places where work is not soulless or demeaning, but where we can find meaning and purpose.

And when we find this, we find that it's not just about personal satisfaction. It involves a sense of community, of participating in something bigger than ourselves. In that sense, work is "the nomadic tribe of our modern culture."







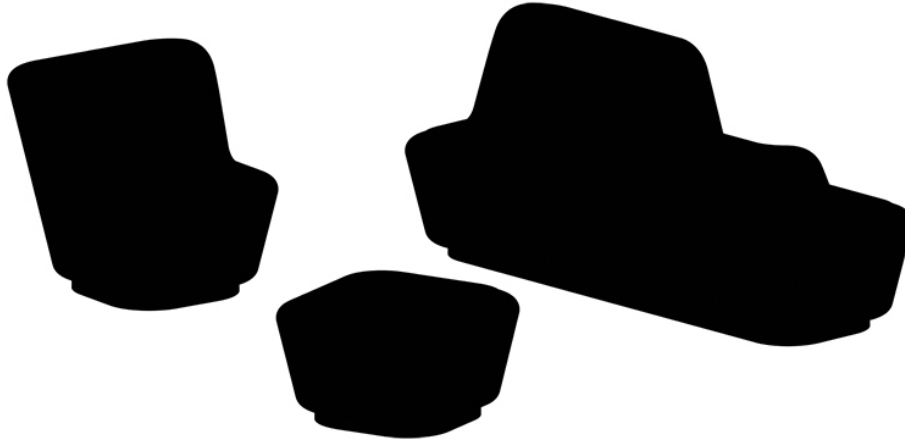

CUSTOMER SERVICE

We are here to help.
Please don't hesitate to contact us.

E-MAIL

info@spell-online.com

PHONE

+31 (0)26 36 101 62

spell[®]

© 2019 Spell - All rights reserved

Although the documentation has been set up with most carefulness,
we do not accept any responsibility for mistakes, inaccuracies or printer's errors.