

## SWAY SLIM SERIES

### Product Specification Sheet

---



---

This document contains technical information about the Sway Series

---



## Description

The Sway table series is designed to offer interaction, communication and intimacy. This elegant slimmer round table version is crafted in Holland from sustainable solid oak.

You can add a discreet outlet for cables in the center of the table. The simple lines of the Sway Series are designed to form a perfect foundation in a dining area, library or any work place, making them look elegant and timeless.

## Specifications

Tabletop  
Premium Solid Wood 30mm

Base  
Premium Solid Wood

Accessible electrification  
Various options

Including felt gliders

Pre assembled: No

## Materials

Solid premium Oak, Walnut or ash wood

Oiled or stained colours, finished in satin matt lacquer

## Customizable

View the full color overview on our website or download the material information sheet.

The complete Sway Series offers a broad range of furnishing options for both private and public spaces. The Sway models can be equipped with electrification applications, such as wireless charging or powersupply.



## Configurations

### Side table low 40-46 cm high

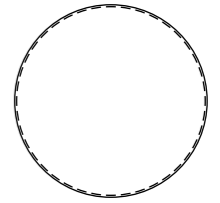
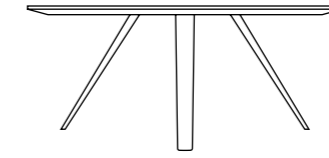

### Side table high 46 - 66 cm high

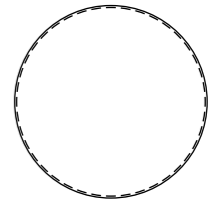
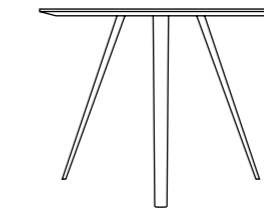

### Table 74 - 76cm high

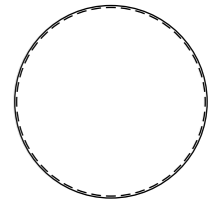
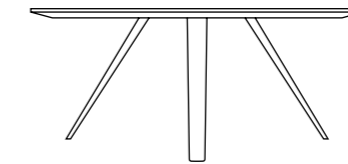
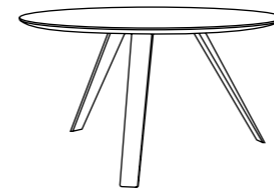

### Bar 90 -110cm high

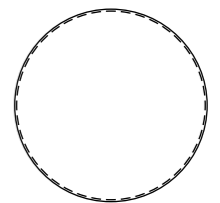
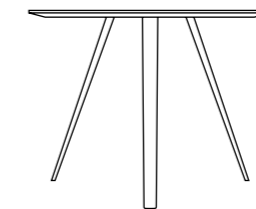
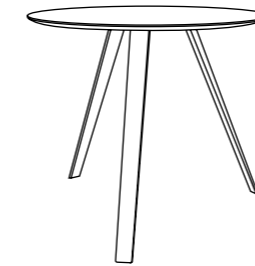

### Table oval 74 - 76 cm high

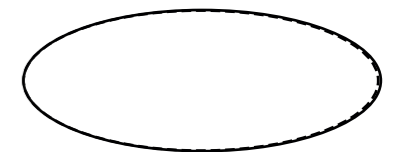
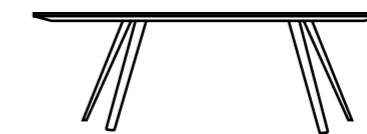

All our solid wood tables are made to measure and can be manufactured in (all) custom sizes.

## Configurations

### Table Endless 74 - 76 cm high

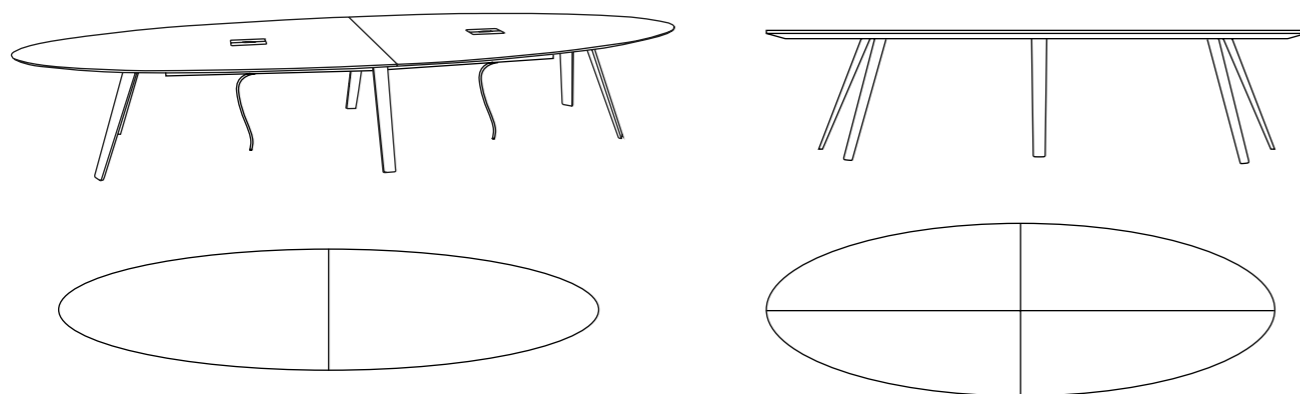

## Example dimensions

All our solid wood tables are made to measure and can be manufactured in (all) custom sizes.

### Side table

- ∅: 40cm x Height: 40-66 cm (3 legs)
- ∅: 50cm x Height: 40-66 cm (3 legs)
- ∅: 60cm x Height: 40-66 cm (3 legs)
- ∅: 70cm x Height: 40-66 cm (3 legs)
- ∅: 75cm x Height: 40-66 cm (3 legs)

### Bar

- ∅: 90cm x Height: 90 - 110cm (3 legs)
- ∅: 100cm x Height: 90 - 110cm (3 legs)
- ∅: 110cm x Height: 90 - 110cm (3 legs)
- ∅: 120cm x Height: 90 - 110cm (3 legs)
- ∅: 130cm x Height: 90 - 110cm (3 legs)
- ∅: 140cm x Height: 90 - 110cm (3 legs)
- ∅: 150cm x Height: 90 - 110cm (4 legs)
- ∅: 160cm x Height: 90 - 110cm (4 legs)
- ∅: 170cm x Height: 90 - 110cm (4 legs)
- ∅: 180cm x Height: 90 - 110cm (4 legs)

### Table

- ∅: 90cm x Height: 74-76cm (3 legs)
- ∅: 100cm x Height: 74-76cm (3 legs)
- ∅: 120cm x Height: 74-76cm (3 legs)
- ∅: 130cm x Height: 74-76cm (3 legs)
- ∅: 150cm x Height: 74-76cm (3 legs)
- ∅: 160cm x Height: 74-76cm (4 legs)
- ∅: 180cm x Height: 74-76cm (4 legs)
- ∅: 200cm x Height: 74-76cm (4 legs)
- ∅: 240cm x Height: 74-76cm (5 legs)

### Oval table

- 160cm x 90-130 x 74-76cm (4 legs)
- 180cm x 90-130 x 74-76cm (4 legs)
- 200cm x 90-130 x 74-76cm (4 legs)
- 240cm x 90-130 x 74-76cm (4 legs)
- 260cm x 90-130 x 74-76cm (4 legs)
- 280cm x 90-130 x 74-76cm (4 legs)
- 300cm x 90-130 x 74-76cm (4 legs)
- 320cm x 90-130 x 74-76cm (4 legs)

### Endless table

- 360cm x 120 x 74-76cm (6 legs, table top consist of 2 parts)
- 400cm x 120 x 74-76cm (6 legs, table top consist of 2 parts)
- 420cm x 120 x 74-76cm (6 legs, table top consist of 2 parts)
- 460cm x 130 x 74-76cm (6 legs, table top consist of 2 parts)
- 490cm x 130 x 74-76cm (6 legs, table top consist of 2 parts)
- 520cm x 130 x 74-76cm (6 legs, table top consist of 2 parts)
- 520cm x 130 x 74-76cm (6 legs, table top consist of 2 parts)
- 560cm x 140 x 74-76cm (6 legs, table top consist of 2 parts)
- 600cm x 140 x 74-76cm (6 legs, table top consist of 2 parts)

All our solid wood tables are made to measure and can be manufactured in (all) custom sizes.

## Edge finish options

### Chamfered

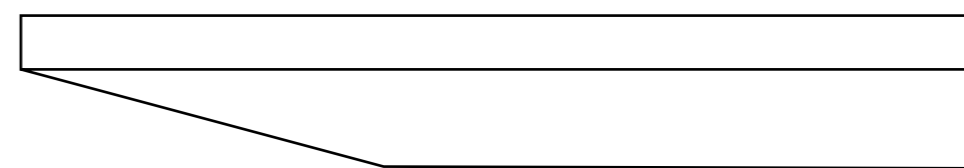

### Straight



## Cable management & electrification options

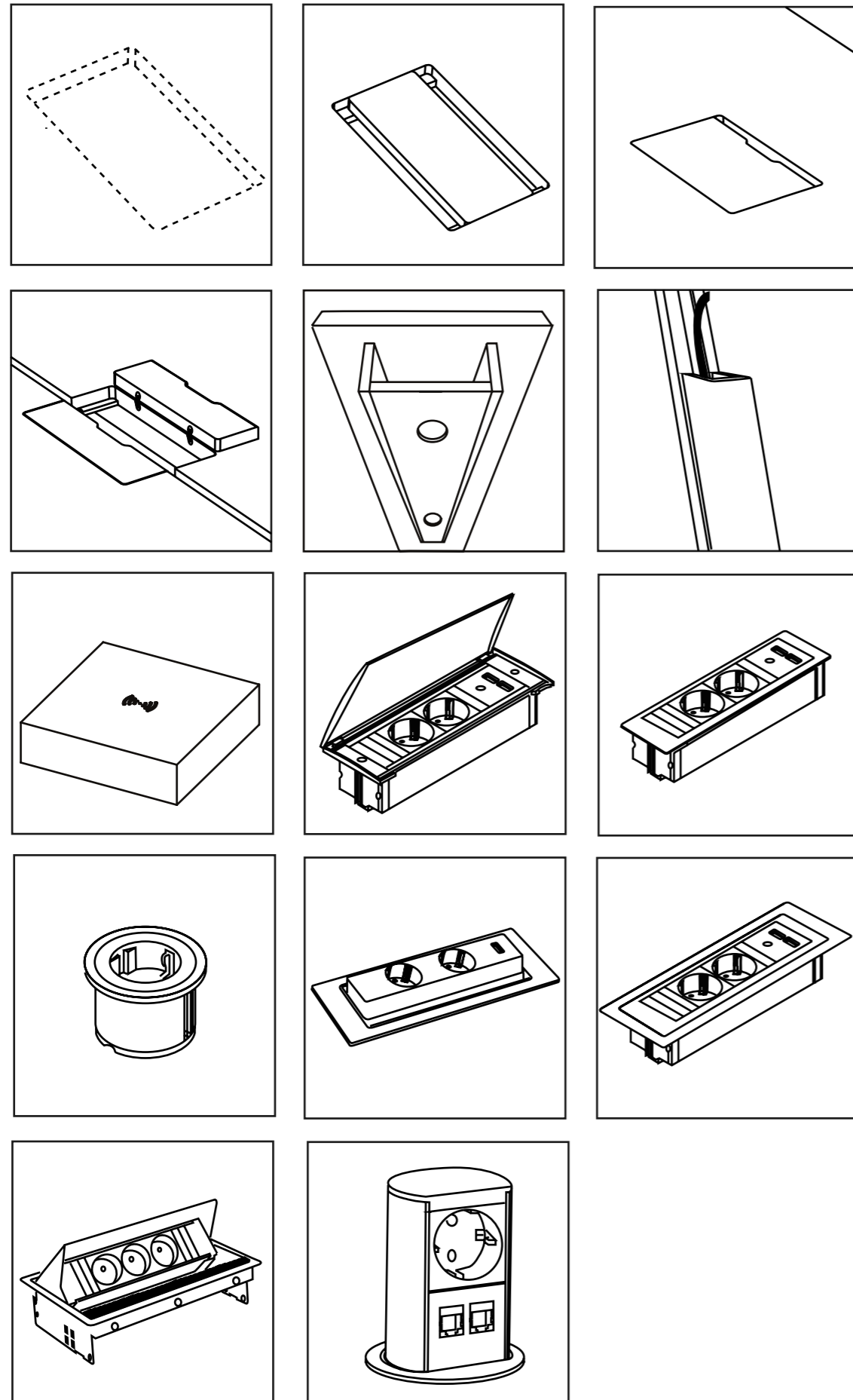

## Case studies

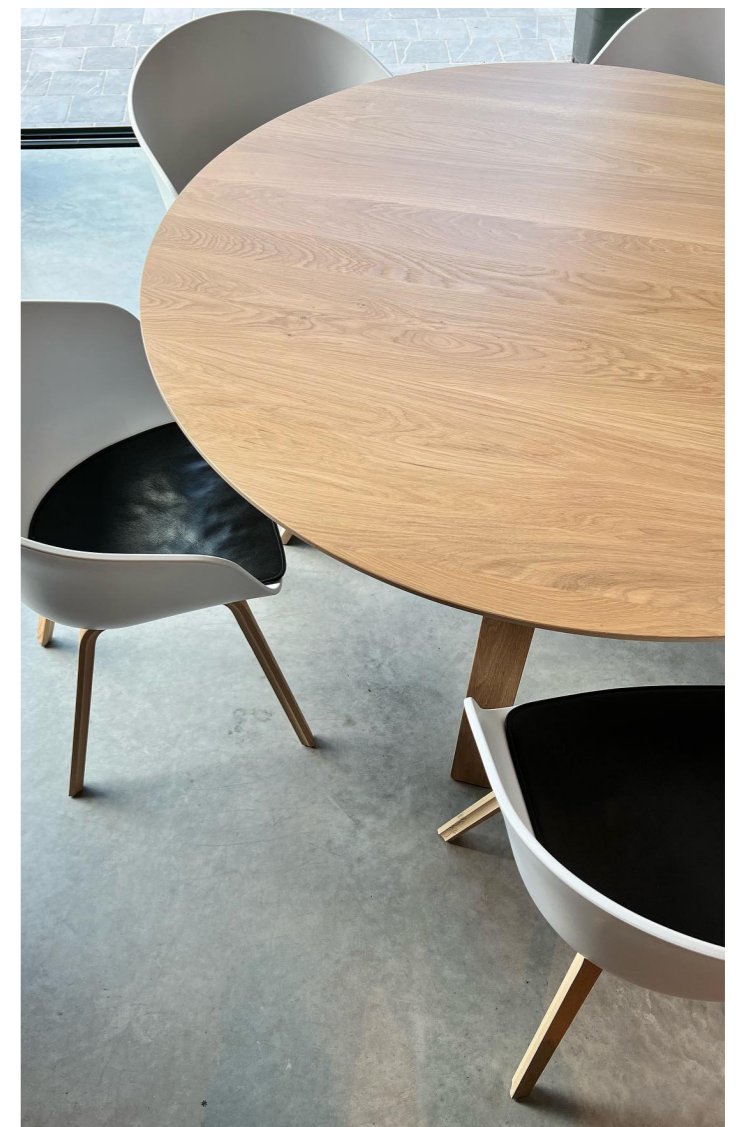



Custom Sway table based on ø: 120cm x ø: 160cm x ø: 200cm



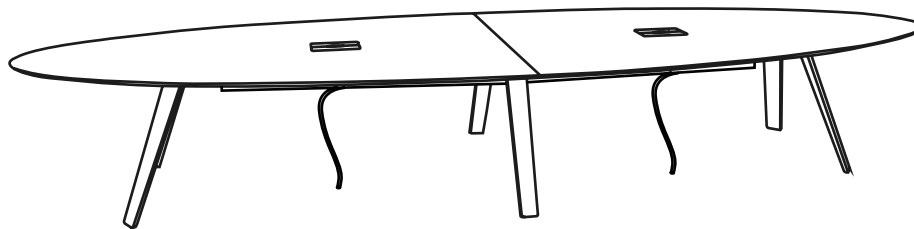

## **SUPPORT**

We are here to help.  
If you have any questions,  
please don't hesitate to contact us.

## **E-MAIL**

[info@spell-furniture.com](mailto:info@spell-furniture.com)

## **PHONE**

+31 (0) 344 842765

*spell*<sup>®</sup>

© Spell B.V. All rights reserved